



**Witt**

Publication No. WT-WDS-0119A  
Replaces document WT-WDS-1017A

# Quantum Air REMOTE AIR COOLED CONDENSER



  
2017  
DEALER DESIGN  
AWARDS  
the NEWS | GOLD  
**GOLD AWARD  
WINNER**  
2017 Best New  
Refrigeration  
Product



## Efficient and Reliable

Witt's Remote Air Cooled Condensers' innovative design provides a wide array of solutions focusing on performance, energy efficiency, reduced sound output and other attributes to meet the needs of the grocery, supermarket, industrial cooling and commercial warehousing industries.

### Standard Features

- Inverter Duty rail mounted motors
- Vertical air flow
- Motors with inherent thermal overload protection
- 3/8" refrigerant saving copper tube, aluminum fin coils\*
- 650 PSIG working pressure
- Vinyl coated heavy gauge steel fan guards
- Swept wing fan/Venturi improves airflow and sound
- Hinged Venturi panels for easy servicing
- Hinged leg design for simple installation
- Proprietary floating coil
- Thru-the-door non-fused disconnect switch
- Heavy gauge painted galvanized steel construction
- Heavy duty lifting eyes for equipment rigging
- UL and cUL listed for outdoor use
- LED control panel lighting
- California Title 24 compliant - see pages 12-15 and 18-19 for applicable models and details

### Options

- Fan cycling head pressure control
- Flooded head pressure control
- Subcooling circuit
- Horizontal air flow
- Multi-circuited coils
- Wide selection of fin coatings and materials
- Individual motor fusing
- Individual or paired motor contactors
- EMS control options
- Variable frequency drives
- Multiple control panel locations
- Multiple refrigerant options
- Thru-the-door fused disconnect
- Main circuit breaker disconnect
- Leg height up to 46" (18" standard)
- Fixed box style legs (25")

### MODEL NUMBER NOMENCLATURE

W	D	D	0	8	7	G	D	3	A
1	2	3	4	5	6	7	8	9	10
Position Number and Description									
<b>1</b>	<b>Model Series</b> - W = Witt Model				<b>8</b>	<b>Motor</b>			
<b>2</b>	<b>Unit Type</b> - D = Condenser					B – 1140 RPM, 1.5 HP Motor			
<b>3</b>	<b>Width</b>					D – 850 RPM, 1.5 HP Motor			
	S = Single Wide					L – 850 RPM, 1 HP Motor			
	D = Double Wide					E – 550 RPM, 1/3 HP Motor			
<b>4-6</b>	<b>Capacity (MBTUH)**</b>					G – 900 RPM Variable Speed EC Motor (Rail Mtd.)			
<b>7</b>	<b>Voltage Code</b>					K – 1200 RPM Variable Speed EC Motor (Rail Mtd.)			
	E – 208-230V/3/60		N – 200-220V/3/50			(Enclosed Motors are an option available for certain Voltage/RPM combinations)			
	G – 460V/3/60		Q – 380V/3/50			<b>9</b>			
	J – 575V/3/60		X – Other -			<b>Number of Fans Long</b> - 1 to 7			
	Non-catalogued				<b>10</b>	<b>Vintage Code</b>			

Table of Contents	Page(s)
Features and Options Chart .....	3
Highlighted Features Diagrams .....	4
Condenser Selection Procedure .....	5-7
Performance and Specifications	
1140 RPM Models with 1.5 HP Motors .....	8-9
850 RPM Models with 1.5 HP Motors .....	10-11
850 RPM Models with 1 HP Motors .....	12-13
550 RPM Models with 1/3 HP Motors .....	14-15
1200 RPM Models with VSEC Motors .....	16-17
900 RPM Models with VSEC Motors .....	18-19
Head Pressure Control Calculations and Settings .....	20-21
Fan Cycling Control and Fan Speed Control Options .....	21-22
Physical Dimensions and Drawings .....	23-24

\* Models with 1 to 4 fans in length have 3/8" copper tubing, which results in using less refrigerant. Models with 5 to 7 fans in length use 1/2" copper tubing.

\*\* Capacity at 10 FPI per 1°FTD

# Remote Air Cooled Condensers

## Features and Options

	DESCRIPTION		
<b>GENERAL CONSTRUCTION</b>	Vertical Air Discharge Configuration		STANDARD
	Horizontal Air Discharge Configuration		OPTIONAL
	Painted Galvanized Steel Casing		STANDARD
	Stainless Steel 316 or Aluminum Casing		OPTIONAL
	Folding Leg Configuration (Vertical Discharge):	Leg Length 18"	STANDARD
Leg Length 21" or 30" or 46"		OPTIONAL	
<b>CONDENSER COIL AND CIRCUITING</b>	Proprietary Floating Coil Design		STANDARD
	Headers constructed with Extruded Field Connections and Pulled Circuit Connections to eliminate leaks		STANDARD
	Galvanized Tube Sheets		STANDARD
	Copper Tubes Mechanically Expanded into Aluminum Fins		STANDARD
	650 PSIG working pressure for high pressure refrigerants		STANDARD
	Coil Circuiting:	Single Circuit	STANDARD (Single)
		50/50	STANDARD (Double)
		50/25/25 or 25/25/25/25	OPTIONAL
Field Manifold Kit to convert 50/50 split to 100% on double wide models		OPTIONAL	
Multi-Circuiting		OPTIONAL	
Subcooling Circuits		OPTIONAL	
<b>FIN MATERIALS, SPACING AND COATINGS</b>	Fin Spacing:	10 Fins per inch	STANDARD
		8, 12 or 14 Fins Per Inch	OPTIONAL
	Fin Materials:	Aluminum Fins	STANDARD
		Copper Fins or Polyester-Coated Fin Stock	OPTIONAL
Fin Coatings:	None	STANDARD	
	ElectroFin® or Heresite, or Energy Guard	OPTIONAL	
<b>FAN/ MOTOR</b>	Universal Rail Motor Mount Design		STANDARD
	Fully Baffled Fan Modules		STANDARD
	Motor Type:	Inverter Duty, Open Type	STANDARD
		Variable Speed EC Motors (VSEC)	OPTIONAL
		Enclosed	OPTIONAL**
Hinged Fan Panels - Easy access for Coil Cleaning and Fan/Motor Service		STANDARD	
<b>CONTROL PANEL</b>	Mounting Location:	Opposite Header End	STANDARD
		Left hand or Right hand (viewing header) or Header End	OPTIONAL
	Temp. or Press. Fan Cycling - Individual or Paired-Fan Contactors (Must specify)		OPTIONAL
	Custom Fan Cycling Wiring and Logic		OPTIONAL
	Variable Speed Header End Fan Control - Pressure Controlled		OPTIONAL
	Factory Mounted EMS Control Board(s):	CPC, Novar, Danfoss, or MicroThermo	OPTIONAL
		Custom Control Boards	OPTIONAL
	Motor Fusing - Individual or in Pairs		OPTIONAL
	Circuit Breakers- Individual or in Pairs		OPTIONAL
	Fan Control Circuit Toggle Switches		OPTIONAL
	Control Transformer 24V, 120V (230V Standard)		OPTIONAL
	Non-Fused Thru-the-Door Disconnect Switch (Mounted)		STANDARD
	Fused Thru-the-Door Disconnect Switch (Mounted)		OPTIONAL
	LED Control Panel Lighting		STANDARD
Variable Frequency Drive (VFD) Options:**	Shipped loose VFD packages	OPTIONAL	
	Factory Mounted and Wired VFD	OPTIONAL	
	Inverter Location - Control Panel End or Side	OPTIONAL	
110 VAC 20 Amp Convenience Outlet powered by Separate Building Feed or Transformer		OPTIONAL	
<b>REFRIGERANT SPECIALTIES</b>	Flooded-Condenser Control Valve System (Loose)		OPTIONAL
	Condenser Receiver Assembly		OPTIONAL
	Liquid Level Options:	Dial Indicator and Level Switch	OPTIONAL
		Electronic Level Indicator	OPTIONAL
	Heated and Insulated Receiver		OPTIONAL
Galvanized Steel Base Frame		OPTIONAL	
<b>SHIPPING</b>	Vertical Air Discharge Models - Legs folded - Unit on skid or crate		STANDARD
	Horizontal Air Discharge Models - Legs Disassembled - Unit on skid or crate		STANDARD

\* Models with 1 to 4 fans in length have 3/8" copper tubing, which results in using less refrigerant. Models with 5 to 7 fans in length use 1/2" copper tubing.

\*\* Option available for 1140 RPM, 1.5 HP; 850 RPM, 1.0 HP; and 850 RPM, 1.5 HP motors.

# Quantum Air

## Highlighted Features and Options

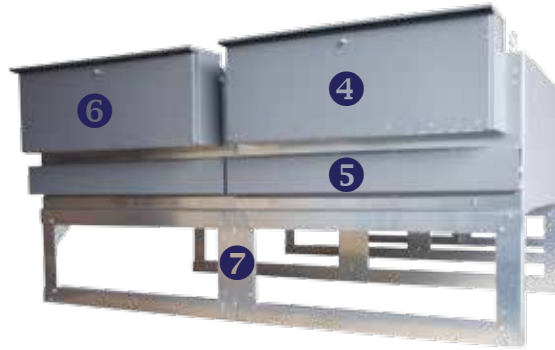
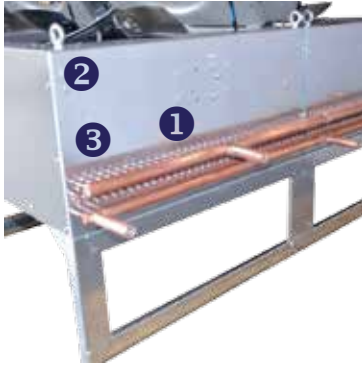

### GENERAL

#### Standard Features

1. Proprietary floating coil design
2. Heavy duty lifting eyes
3. Copper headers constructed with extruded field connections and pulled circuit connections to eliminate leaks
4. Hinged and lighted control panel(s)
5. Return bend cover
6. Heavy gauge painted galvanized steel construction
7. 18" folding leg design for ease of installation

#### Optional Features

- Subcooling circuit
- Multi-sectioned coils
- Leg length of 21", 30" or 46"
- Fixed box style legs (25")
- Many more



### CONTROL PANEL

#### Standard Features

1. LED lighted compartment
2. Thru-the-door non-fused disconnect
3. Controls and wiring clearly labeled and identified on wiring diagram for easy servicing

#### Optional Features

- Multiple control panel locations
- Thru-the-door **fused** disconnect
- Main circuit breaker disconnect
- Fan cycling or flooded head pressure control
- Factory-mounted EMS Control Boards



### MOTORS

#### Standard Features

1. Swept wing fan for optimal airflow
2. Inverter duty motors
3. Fixed motor rail studs partially retain motor for ease of installation
4. Hinged venturi panels for quicker service
5. Gas filled struts hold fan panels securely in upright position
6. Vinyl coated heavy gauge steel fan guards

#### Optional Features

- Horizontal air flow
- Copper or coated fins
- Individual and paired motor fusing

## Condenser Selection

Air-cooled condenser capacity ratings are based on the total heat rejection of the refrigeration system. Total heat of rejection is the sum of the compressor capacity and heat of compression added to the refrigerant in the compressor.

The heat of compression varies with the compressor design, so the compressor manufacturer's information should be used whenever possible. If the compressor manufacturer's heat of compression information is not available, Tables 2 and 3 (page 7) may be used to determine the heat of compression.

The following formulas may be used to calculate the total heat rejection (THR) for systems that fall outside the normal limits of single stage compressor applications, such as compound or cascade systems.

Suction cooled hermetic compressors:  $THR = \text{Compressor Capacity (BTUH)} + (3413 \times \text{KW})$

Open Compressors:  $THR = \text{Compressor Capacity (BTUH)} + (2545 \times \text{BHP})$

### ELEVATION CORRECTION

Elevation above sea level has an effect on the performance of air cooled condensers. Divide the required capacity by the Elevation Correction Factor in the table on page 7 to correct the requirement to Sea Level Conditions. The proper condenser can then be selected from the appropriate table on Pages 8,10,12,14, 16 or 18.

### SINGLE CIRCUIT CONDENSERS

All units are available for single circuit applications. All double fan width units are furnished with dual circuit coils and can be converted in the field for single circuit installations.

### SELECTION EXAMPLE

#### Given:

Ambient Air Temperature = 100° F

Midpoint Condensing Temperature\* = 115° F

Evaporating Temperature = +20° F

Compressor Type = Suction Cooled Semi-Hermetic

\*Refer to Midpoint Selection Graph for explanation

Design DT = 15° F

Refrigerant = R407A

Compressor Capacity = 140,000

#### Solution:

Multiply the compressor capacity by the heat of compression factor to calculate the required total heat of rejection (THR). Table 2 shows that for 115°F condensing temperature and 20° F evaporator temperature, the heat of compression factor is 1.35. The required total heat rejection (THR) is:  $140,000 \times 1.35 = 189,000 \text{ BTUH THR}$

Divide the system THR by the condenser delta T (Midpoint Temperature-Ambient Air) =  $189,000 \div 15 = 12,600 \text{ BTUH per } 1^\circ\text{FTD}$

Convert BTUH to MBH =  $12,600 \text{ BTUH} \div 1,000 = 12.6 \text{ MBH per } 1^\circ\text{FTD}$

The correct selection of a single fan width unit with 850 RPM 1 HP fans and 10 FPI is a model WDS015<sup>A</sup>L2 with a capacity of 15.1 MBH.

Since the unit selection will almost never have the exact required capacity, the actual TD will vary slightly from the design TD. The actual TD can be calculated using the following formula:

$$\text{Actual TD} = \frac{\text{Design THR}}{\text{Actual Condenser THR}} \times \text{Design TD}$$

For this example the actual TD would be:

$$\text{Actual TD} = \frac{12.6}{15.1} \times 15 = 12.5^\circ\text{FTD}$$

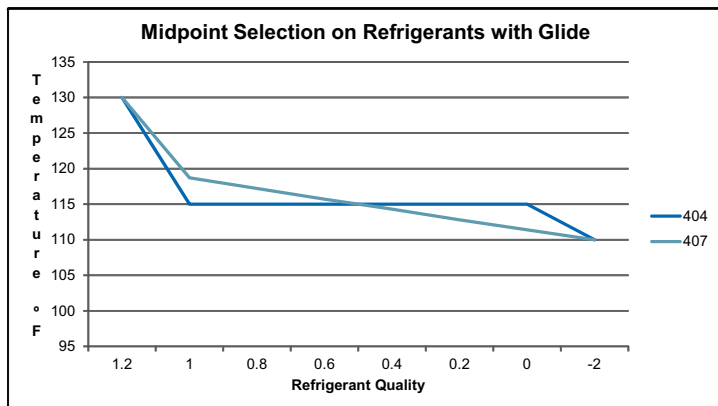

\* To avoid oversizing, the condenser is selected at the Midpoint Temperature. The Midpoint is the average of the Dew Point and Bubble Point temperatures corresponding to the conditions at the condenser inlet.

The Refrigerant Quality in the chart refers to the percentage of vapor in a saturated mixture. The glide occurs across the change from liquid to vapor.

BTUH capacities published in this document for refrigerants other than R404A are based upon this Midpoint Selection Chart.

## Multi-Circuited Condensers

Air-cooled condensers are available for applications where multiple refrigeration systems are connected to the same condenser. Multi-Circuiting is covered in this section.

The condenser coil is divided into the proper number of circuits and each circuit is supplied with an inlet and outlet connection. Each circuit is tagged at the factory for identification. When ordering, the circuits must be placed on the purchase order in numerical sequence. The circuits will be arranged in sequence with the number one circuit being on the left end when facing the header end of the unit.

### EXAMPLE: MULTI-CIRCUITED CONDENSER SELECTION

#### Given:

Refer to Table 1, the Multi-Circuit Calculation Form below. Four suction cooled semi-hermetic compressors are shown with their operating conditions. Design ambient temperature is 95° F.

#### Procedure:

1. Complete the customer data in columns 1 through 6 in Table 1.
2. Fill in the heat of compression factors in column 7. If the compressor manufacturer's data is not available, use values from tables 2 and 3.
3. Multiply the values in column 6 by the values in column 7 and tabulate the results in column 8.
4. Next, divide the heat rejection values in column 8 by the design TD values in column 3 and enter the results in column 9.
5. Add all of the items in column 9 to obtain the total MBH required at 1° FTD. Use this value and the procedure on Page 5 to select the proper condenser model. For this example, the total MBH is 25.6. Therefore, the unit with 1140 RPM fan motors and double fan-width configuration, having enough capacity to meet this requirement, is an WDD030\*B2 with 10 FPI.
6. MBH per face tube values can be found by dividing the unit's capacity, found in the performance data tables, by the number of face tubes listed in Table 5 (page 21). Be sure to apply the corresponding correction factors for refrigerants other than R404A or R407A. Enter the MBH per face tube value in column 10.
7. To determine the number of face tubes required for each circuit, divide column 9 by column 10 and enter the results in column 11.
8. Each circuit's number of face tubes in column 11 is a mathematical value and must be rounded off to a whole number and entered into column 12. Round each number off such that the section size assigned to each system is no smaller than 10% undersized.
9. Total the values in column 12. The sum must equal the number of face tubes available for the WDD030\*B2 as shown in Table 5 (page 21). If it does not, one or more of the column 12 numbers will have to be adjusted so the sum does equal the available face tubes.
10. The actual TD in each coil circuit may vary slightly from the design TD. The actual TD can be calculated using the following formula:

$$TD = \frac{\text{Design TD} \times \text{adjusted THR} @ 1^\circ \text{TD}}{\text{MBH per tube} @ 1^\circ \text{TD} \times \text{No. of Tubes used}}$$

The actual TD for Circuit No. 3 would be:

$$TD = \frac{10 \times 4.98}{0.43 \times 15} = 7.7^\circ \text{F}$$

Table 1: Multi-Circuit Calculation Form

1	2	3	4	5	6	7	8	9	10	11	12
Circuit No.	Refrig. Type	Design TD (°F)	Cond. Temp. (°F)	Evap. Temp. (°F)	Compressor Capacity (MBH)	Heat of Compression Factor	Heat Rejection	Adjusted THR (MBH) 1°FTD	MBH Per Face Tube	No. of Face Tubes Required	No. of Face Tubes Selected
1	407A	15	110	20	96.5	1.33	128.3	8.56	0.42	20.54	24
2	407A	15	110	20	81.1	1.33	107.9	7.19	0.42	17.26	20
3	404	10	105	-25	31.1	1.6	49.8	4.98	0.43	11.71	14
4	404	10	105	-25	28.9	1.7	49.1	4.91	0.43	11.56	14

# Remote Air Cooled Condensers

## Table 2: Heat of Compression Factors

### Suction Cooled Compressors

Evap Temp °F	Condensing Temperature °F								
	90	95	100	105	110	115	120	125	130
-40	1.66	1.70	1.73	1.76	1.80	1.90	2.00	†	†
-35	1.61	1.64	1.68	1.70	1.74	1.82	1.90	†	†
-30	1.57	1.60	1.62	1.65	1.68	1.74	1.80	†	†
-25	1.53	1.56	1.58	1.60	1.63	1.67	1.72	†	†
-20	1.49	1.51	1.53	1.55	1.58	1.61	1.65	†	†
-15	1.46	1.48	1.50	1.51	1.54	1.57	1.61	†	†
-10	1.42	1.44	1.46	1.48	1.50	1.53	1.57	1.60	1.64
-5	1.39	1.41	1.43	1.45	1.47	1.50	1.53	1.56	1.60
0	1.36	1.38	1.40	1.42	1.44	1.47	1.50	1.53	1.56
+5	1.33	1.35	1.37	1.39	1.41	1.43	1.46	1.49	1.52
+10	1.31	1.32	1.34	1.36	1.38	1.40	1.43	1.46	1.49
+15	1.28	1.30	1.32	1.33	1.35	1.37	1.40	1.43	1.46
+20	1.26	1.27	1.29	1.31	1.33	1.35	1.37	1.40	1.43
+25	1.24	1.25	1.27	1.29	1.31	1.33	1.35	1.37	1.40
+30	1.22	1.23	1.25	1.26	1.28	1.30	1.32	1.34	1.37
+35	1.20	1.21	1.23	1.25	1.26	1.27	1.29	1.31	1.34
+40	1.18	1.19	1.21	1.23	1.24	1.25	1.27	1.29	1.31
+45	1.16	1.17	1.19	1.21	1.22	1.23	1.25	1.26	1.28
+50	1.14	1.15	1.17	1.19	1.20	1.22	1.23	1.24	1.26

A. † Beyond the normal limits for single stage compressor application.

## Table 3: Heat of Compression Factors

### Open Compressors

Evap Temp °F	Condensing Temperature °F								
	90	95	100	105	110	115	120	125	130
-30	1.37	1.39	1.42	1.44	1.47	†	†	†	†
-20	1.33	1.35	1.37	1.39	1.42	1.44	1.47	†	†
-10	1.28	1.30	1.32	1.34	1.37	1.39	1.42	1.44	1.47
0	1.24	1.26	1.28	1.30	1.32	1.34	1.37	1.39	1.41
+10	1.21	1.23	1.24	1.26	1.28	1.30	1.32	1.34	1.36
+20	1.17	1.18	1.20	1.22	1.24	1.26	1.28	1.30	1.32
+30	1.14	1.15	1.17	1.18	1.20	1.22	1.24	1.25	1.27
+40	1.12	1.14	1.15	1.16	1.17	1.18	1.20	1.21	1.23
+50	1.09	1.11	1.12	1.13	1.14	1.16	1.17	1.19	1.20

A. † Beyond the normal limits for single stage compressor application.

## Table 4: Elevation Correction Factors

Elevation (ft)	1,000	2,000	3,000	4,000	5,000	6,000	8,000	10,000	12,000	14,000	16,000
Correction Factor	0.94	0.93	0.90	0.88	0.86	0.83	0.79	0.75	0.71	0.66	0.62

## Performance Data - 1140 RPM with 1.5 HP Fan Motors

THR MBH 1°F TD - R407A, R448A, R449A

Model Number	Fins Per Inch			
	8	10	12	14

### SINGLE FAN WIDTH

WDS004*B1*	4.0	4.4	4.7	4.9
WDS006*B1*	5.5	6.1	6.4	6.7
WDS007*B1*	6.9	7.5	7.9	8.3
WDS012*B2*	10.9	11.9	12.6	13.2
WDS015*B2*	13.6	14.9	15.8	16.5
WDS018*B2*	16.7	18.3	19.4	20.3
WDS022*B3*	20.5	22.5	23.7	24.9
WDS027*B3*	24.7	27.1	28.6	30.0
WDS030*B4*	27.3	30.0	31.7	33.2
WDS036*B4*	32.7	35.8	37.9	39.7
WDS039*B5*	35.6	39.0	41.2	43.3
WDS047*B5*	42.9	47.1	49.7	52.2
WDS056*B6*	51.4	56.3	59.5	62.4
WDS065*B7*	59.9	65.7	69.4	72.8

### DOUBLE FAN WIDTH

WDD022*B2*	19.8	21.7	23.0	24.1
WDD030*B2*	27.3	30.0	31.7	33.2
WDD036*B2*	32.9	36.1	38.1	39.9
WDD045*B3*	41.0	44.9	47.4	49.8
WDD054*B3*	49.5	54.3	57.3	60.1
WDD059*B4*	54.7	59.9	63.3	66.4
WDD072*B4*	65.5	71.8	75.8	79.5
WDD078*B5*	71.1	78.0	82.3	86.4
WDD094*B5*	86.0	94.2	99.5	104.4
WDD113*B6*	102.8	112.7	119.0	124.9
WDD131*B7*	119.9	131.4	138.8	145.6

THR MBH 1°F TD - R404A

Fins Per Inch			
8	10	12	14

### SINGLE FAN WIDTH

4.2	4.6	4.9	5.1
5.6	6.2	6.5	6.8
7.1	7.8	8.3	8.7
11.2	12.3	12.9	13.6
14.0	15.3	16.2	17.0
16.6	18.2	19.3	20.2
20.9	23.0	24.3	25.4
24.4	26.8	28.3	29.7
27.9	30.6	32.3	33.9
32.4	35.5	37.5	39.4
35.7	39.1	41.3	43.4
41.6	45.6	48.2	50.6
49.8	54.6	57.6	60.5
58.1	63.8	67.3	70.6

### DOUBLE FAN WIDTH

20.9	22.9	24.1	25.3
27.9	30.6	32.3	33.9
32.6	35.7	37.7	39.6
41.8	45.8	48.4	50.8
49.0	53.8	56.8	59.6
55.8	61.2	64.6	67.8
64.7	71.0	74.9	78.6
71.3	78.2	82.6	86.6
83.3	91.4	96.5	101.2
99.7	109.3	115.4	121.1
116.2	127.4	134.5	141.2

\* Each asterisk represents a variable character based upon voltage and vintage ordered. See page 2 for complete nomenclature.  
 For R22 capacity, multiply R404A unit capacity by 1.02  
 For R410A capacity, multiply R404A unit capacity by 1.08  
 For R134a capacity, multiply R404A unit capacity by .97  
 For R407C capacity, multiply R407A unit capacity by .98

#### Notes:

- R407A, R448A and R449A ratings are based on Mean Condensing Temperature which is the average of the Dew Point and Bubble Point temperatures corresponding to the refrigerant temperature at the condenser inlet.



**Application: Food Processing and Warehousing**



# Remote Air Cooled Condensers

## Specifications - 1140 RPM with 1.5 HP Fan Motors

Model Number **	Fans				Max. Circuit Qty.	Connection (Inches) <sup>^</sup>			Net Wt. (Lbs.)	Unit kW	208/3/60			460/3/60			575/3/60		
	Total Qty.	Dia.	CFM	dBA †		Dis.	Liq.	Total Qty.			FLA	MCA	MOPD	FLA	MCA	MOPD	FLA	MCA	MOPD

### SINGLE FAN WIDTH

WDS004*B1*	1	30	10,200	69.8	12	1-1/8	7/8	2	350	1.8	6.5	15.0	15.0	3.3	15.0	15.0	2.2	15.0	15.0
WDS006*B1*	1	30	10,000	69.8	18	1-1/8	7/8	2	375	1.8	6.5	15.0	15.0	3.3	15.0	15.0	2.2	15.0	15.0
WDS007*B1*	1	30	9,800	69.8	24	1-1/8	7/8	2	400	1.8	6.5	15.0	15.0	3.3	15.0	15.0	2.2	15.0	15.0
WDS012*B2*	2	30	20,400	72.8	27	1-3/8	1-1/8	2	725	3.6	13.0	15.0	20.0	6.6	15.0	15.0	4.4	15.0	15.0
WDS015*B2*	2	30	20,000	72.8	27	1-3/8	1-1/8	2	750	3.6	13.0	15.0	20.0	6.6	15.0	15.0	4.4	15.0	15.0
WDS018*B2*	2	30	19,600	72.8	36	1-3/8	1-1/8	2	775	3.6	13.0	15.0	20.0	6.6	15.0	15.0	4.4	15.0	15.0
WDS022*B3*	3	30	30,000	74.6	27	1-5/8	1-3/8	2	1,125	5.4	19.5	21.1	25.0	9.9	15.0	15.0	6.6	15.0	15.0
WDS027*B3*	3	30	29,400	74.6	36	1-5/8	1-3/8	2	1,150	5.4	19.5	21.1	25.0	9.9	15.0	15.0	6.6	15.0	15.0
WDS030*B4*	4	30	40,000	75.8	27	1-5/8	1-3/8	2	1,500	7.2	26.0	30.1	35.0	13.2	15.1	20.0	8.8	15.0	15.0
WDS036*B4*	4	30	39,200	75.8	36	1-5/8	1-3/8	2	1,525	7.2	26.0	30.1	35.0	13.2	15.1	20.0	8.8	15.0	15.0
WDS039*B5*	5	30	50,000	76.8	27	2-1/8	1-5/8	2	1,875	9.0	32.5	34.1	40.0	16.5	17.3	20.0	11.0	15.0	15.0
WDS047*B5*	5	30	49,000	76.8	36	2-1/8	1-5/8	2	1,900	9.0	32.5	34.1	40.0	16.5	17.3	20.0	11.0	15.0	15.0
WDS056*B6*	6	30	58,800	77.6	36	2-1/8	1-5/8	2	2,275	10.8	39.0	40.6	45.0	19.8	20.6	25.0	13.2	15.1	20.0
WDS065*B7*	7	30	68,600	78.2	36	2-1/8	1-5/8	2	2,650	12.6	45.5	47.1	50.0	23.1	25.1	30.0	15.4	16.0	20.0

### DOUBLE FAN WIDTH

WDD022*B2*	4	30	40,800	75.8	36	1-3/8	1-1/8	4	1,500	7.2	26.0	30.1	35.0	13.2	15.1	20.0	8.8	15.0	15.0
WDD030*B2*	4	30	40,000	75.8	54	1-3/8	1-1/8	4	1,525	7.2	26.0	30.1	35.0	13.2	15.1	20.0	8.8	15.0	15.0
WDD036*B2*	4	30	39,200	75.8	72	1-3/8	1-1/8	4	1,550	7.2	26.0	30.1	35.0	13.2	15.1	20.0	8.8	15.0	15.0
WDD045*B3*	6	30	61,200	77.6	54	1-5/8	1-3/8	4	2,275	10.8	39.0	40.6	45.0	19.8	20.6	25.0	13.2	15.1	20.0
WDD054*B3*	6	30	58,800	77.6	72	1-5/8	1-3/8	4	2,300	10.8	39.0	40.6	45.0	19.8	20.6	25.0	13.2	15.1	20.0
WDD059*B4*	8	30	80,000	78.8	54	1-5/8	1-3/8	4	3,025	14.4	52.0	53.6	60.0	26.4	27.2	30.0	17.6	18.2	20.0
WDD072*B4*	8	30	78,400	78.8	72	1-5/8	1-3/8	4	3,050	14.4	52.0	53.6	60.0	26.4	27.2	30.0	17.6	18.2	20.0
WDD078*B5*	10	30	100,000	79.8	54	2-1/8	1-5/8	4	3,775	18.0	65.0	66.6	70.0	33.0	35.1	40.0	22.0	22.6	25.0
WDD094*B5*	10	30	98,000	79.8	72	2-1/8	1-5/8	4	3,800	18.0	65.0	66.6	70.0	33.0	35.1	40.0	22.0	22.6	25.0
WDD113*B6*	12	30	117,600	80.6	72	2-1/8	1-5/8	4	4,550	21.6	78.0	80.1	90.0	39.6	40.4	45.0	26.4	27.0	30.0
WDD131*B7*	14	30	137,200	81.2	72	2-1/8	1-5/8	4	5,300	25.2	91.0	92.6	100.0	46.2	47.0	50.0	30.8	31.4	35.0

\* Each asterisk represents a variable character based upon voltage and vintage ordered. See page 2 for complete nomenclature.

\*\* Models with 1 to 4 fans in length have 3/8" copper tubing, which reduces refrigerant charge. Models with 5 to 7 fans in length use 1/2" copper tubing, which reduces pressure drop.

† Sound pressure dBA @ 10 feet.

^ Standard connection sizes are for no circuit split on single wide and 50/50 circuit split on double wide models. Header diameters are one size larger than connection sizes.

Variance from standard operating conditions may result in connection sizes which are different from those listed above.



Lighted electrical control panel

Generously sized control box

Non-fused thru-the-door disconnect

Clearly labeled wires and controls

Wiring diagram affixed to panel door

## Performance Data - 850 RPM with 1.5 HP Fan Motors

THR MBH 1°F TD - R407A, R448A, R449A

Model Number	Fins Per Inch			
	8	10	12	14

## SINGLE FAN WIDTH

WDS004*D1*	3.3	3.6	3.8	4.0
WDS005*D1*	4.7	5.2	5.4	5.7
WDS007*D1*	5.9	6.5	6.8	7.1
WDS010*D2*	9.0	9.9	10.5	10.9
WDS014*D2*	12.6	13.8	14.6	15.2
WDS015*D2*	13.9	15.3	16.1	16.8
WDS021*D3*	19.1	20.9	22.1	23.0
WDS024*D3*	22.3	24.4	25.8	26.9
WDS028*D4*	25.2	27.7	29.2	30.4
WDS032*D4*	29.4	32.2	34.0	35.4
WDS035*D5*	31.5	34.5	36.5	38.0
WDS043*D5*	39.3	43.1	45.5	47.4
WDS052*D6*	47.2	51.7	54.6	56.9
WDS060*D7*	55.0	60.3	63.7	66.3

## DOUBLE FAN WIDTH

WDD019*D2*	17.5	19.2	20.3	21.1
WDD028*D2*	25.2	27.7	29.2	30.4
WDD031*D2*	28.6	31.3	33.1	34.4
WDD041*D3*	37.5	41.1	43.4	45.2
WDD048*D3*	44.1	48.4	51.1	53.2
WDD055*D4*	50.6	55.4	58.6	61.0
WDD065*D4*	58.9	64.5	68.2	71.0
WDD069*D5*	63.0	69.1	73.0	76.0
WDD086*D5*	78.6	86.2	91.0	94.8
WDD103*D6*	94.2	103.3	109.1	113.7
WDD121*D7*	110.0	120.6	127.3	132.7

THR MBH 1°F TD - R404A

Model Number	Fins Per Inch			
	8	10	12	14

## SINGLE FAN WIDTH

	3.7	4.0	4.3	4.7
	5.1	5.6	5.9	6.5
	6.3	6.9	7.3	8.0
	9.5	10.4	11.0	12.1
	12.8	14.0	14.8	16.3
	14.3	15.7	16.5	18.2
	19.3	21.2	22.4	24.6
	21.9	24.0	25.4	27.9
	25.7	28.2	29.8	32.7
	28.9	31.7	33.5	36.8
	31.4	34.4	36.4	40.0
	37.9	41.5	43.8	48.2
	45.4	49.8	52.6	57.8
	53.1	58.2	61.4	67.6

## DOUBLE FAN WIDTH

	18.4	20.2	21.3	23.5
	25.6	28.1	29.7	32.6
	28.1	30.8	32.5	35.8
	38.0	41.7	44.0	48.5
	43.4	47.6	50.2	55.3
	51.4	56.4	59.5	65.5
	57.8	63.4	67.0	73.7
	62.9	69.0	72.8	80.1
	75.8	83.1	87.8	96.6
	90.9	99.7	105.3	115.8
	106.0	116.3	122.8	135.0

\* Each asterisk represents a variable character based upon voltage and vintage ordered. See page 2 for complete nomenclature.

For R22 capacity, multiply R404A unit capacity by 1.02

For R410A capacity, multiply R404A unit capacity by 1.08

For R134a capacity, multiply R404A unit capacity by .97

For R407C capacity, multiply R407A unit capacity by .98

**Notes:**

- R407A, R448A and R449A ratings are based on Mean Condensing Temperature which is the average of the Dew Point and Bubble Point temperatures corresponding to the refrigerant temperature at the condenser inlet.

# Remote Air Cooled Condensers

## Specifications - 850 RPM with 1.5 HP Fan Motors

Model Number **	Fans				Max. Circuit Qty.	Connection (Inches)^			Net Wt. (Lbs.)	Unit kW	208/3/60			460/3/60			575/3/60		
	Total Qty.	Dia.	CFM	dBA †		Dis.	Liq.	Total Qty.			FLA	MCA	MOPD	FLA	MCA	MOPD	FLA	MCA	MOPD
WDS004*D1*	1	30	8,600	62.2	12	1-1/8	7/8	2	350	1.5	6.5	15.0	15.0	3.3	15.0	15.0	-	-	-
WDS005*D1*	1	30	8,400	62.2	18	1-1/8	7/8	2	375	1.5	6.5	15.0	15.0	3.3	15.0	15.0	-	-	-
WDS007*D1*	1	30	8,210	62.2	24	1-1/8	7/8	2	400	1.5	6.5	15.0	15.0	3.3	15.0	15.0	-	-	-
WDS010*D2*	2	30	17,200	65.2	18	1-3/8	1-1/8	2	725	2.9	13.0	15.0	20.0	6.6	15.0	15.0	-	-	-
WDS014*D2*	2	30	16,800	65.2	18	1-3/8	1-1/8	2	750	2.9	13.0	15.0	20.0	6.6	15.0	15.0	-	-	-
WDS015*D2*	2	30	16,420	65.2	27	1-3/8	1-1/8	2	775	2.9	13.0	15.0	20.0	6.6	15.0	15.0	-	-	-
WDS021*D3*	3	30	25,200	67.0	27	1-5/8	1-3/8	2	1,125	4.4	19.5	21.1	25.0	9.9	15.0	15.0	-	-	-
WDS024*D3*	3	30	24,630	67.0	36	1-5/8	1-3/8	2	1,150	4.4	19.5	21.1	25.0	9.9	15.0	15.0	-	-	-
WDS028*D4*	4	30	33,600	68.2	27	1-5/8	1-3/8	2	1,500	5.8	26.0	30.1	35.0	13.2	15.0	15.0	-	-	-
WDS032*D4*	4	30	32,840	68.2	36	1-5/8	1-3/8	2	1,525	5.8	26.0	30.1	35.0	13.2	15.0	15.0	-	-	-
WDS035*D5*	5	30	42,000	69.2	27	2-1/8	1-5/8	2	1,875	7.3	32.5	34.1	40.0	16.5	17.3	20.0	-	-	-
WDS043*D5*	5	30	41,050	69.2	36	2-1/8	1-5/8	2	1,900	7.3	32.5	34.1	40.0	16.5	17.3	20.0	-	-	-
WDS052*D6*	6	30	49,260	70.0	27	2-1/8	1-5/8	2	2,275	8.7	39.0	40.6	45.0	19.8	20.6	25.0	-	-	-
WDS060*D7*	7	30	57,470	70.6	36	2-1/8	2-1/8	2	2,650	10.2	45.5	47.1	50.0	23.1	25.1	30.0	-	-	-

### SINGLE FAN WIDTH

DOUBLE FAN WIDTH																			
WDD022*B2*	4	30	34,400	68.2	36	1-3/8	1-1/8	4	1,500	5.8	26.0	30.1	35.0	13.2	15.0	15.0	-	-	-
WDD030*B2*	4	30	33,600	68.2	54	1-3/8	1-1/8	4	1,525	5.8	26.0	30.1	35.0	13.2	15.0	15.0	-	-	-
WDD036*B2*	4	30	32,840	68.2	72	1-3/8	1-1/8	4	1,550	5.8	26.0	30.1	35.0	13.2	15.0	15.0	-	-	-
WDD045*B3*	6	30	50,400	70.0	54	1-5/8	1-3/8	4	2,275	8.7	39.0	40.6	45.0	19.8	20.6	25.0	-	-	-
WDD054*B3*	6	30	49,260	70.0	72	1-5/8	1-3/8	4	2,300	8.7	39.0	40.6	45.0	19.8	20.6	25.0	-	-	-
WDD059*B4*	8	30	67,200	71.2	54	1-5/8	1-3/8	4	3,025	11.6	52.0	53.6	60.0	26.4	27.2	30.0	-	-	-
WDD072*B4*	8	30	65,680	71.2	72	1-5/8	1-3/8	4	3,050	11.6	52.0	53.6	60.0	26.4	27.2	30.0	-	-	-
WDD078*B5*	10	30	84,000	72.2	54	2-1/8	1-5/8	4	3,775	14.5	65.0	66.6	70.0	33.0	35.1	40.0	-	-	-
WDD094*B5*	10	30	82,100	72.2	72	2-1/8	1-5/8	4	3,800	14.5	65.0	66.6	70.0	33.0	35.1	40.0	-	-	-
WDD113*B6*	12	30	98,520	73.0	72	2-1/8	1-5/8	4	4,550	17.4	78.0	80.1	90.0	39.6	40.4	45.0	-	-	-
WDD131*B7*	14	30	114,940	73.6	72	2-1/8	2-1/8	4	5,300	20.3	91.0	92.6	100.0	46.2	47.0	50.0	-	-	-

\* Each asterisk represents a variable character based upon voltage and vintage ordered. See page 2 for complete nomenclature.

\*\* Models with 1 to 4 fans in length have 3/8" copper tubing, which reduces refrigerant charge. Models with 5 to 7 fans in length use 1/2" copper tubing, which reduces pressure drop.

† Sound pressure dBA @ 10 feet.

^ Standard connection sizes are for no circuit split on single wide and 50/50 circuit split on double wide models. Header diameters are one size larger than connection sizes.

- Not available in 575V

Variance from standard operating conditions may result in connection sizes which are different from those listed above.



Hinged fan panels and rail mounted motors for easy serviceability

Performance Data - 850 RPM with 1 HP Fan Motors<sup>‡</sup>

THR MBH 1°F TD - R407A, R448A, R449A

Model Number	Fins Per Inch			
	8	10	12	14

## SINGLE FAN WIDTH

WDS004*L1*	4.0	4.4	4.6	4.8
WDS006*L1*	5.6	6.1	6.5	6.7
WDS008*L1*	6.9	7.5	8.0	8.3
WDS010*L2*	8.9	9.8	10.3	10.8
WDS012*L2*	11.1	12.1	12.8	13.4
WDS015*L2*	13.8	15.1	15.9	16.6
WDS019*L3*	17.5	19.2	20.2	21.1
WDS023*L3*	20.7	22.6	23.9	24.9
WDS026*L4*	23.3	25.5	26.9	28.1
WDS030*L4*	27.4	30.1	31.8	33.1
WDS032*L5*	28.8	31.6	33.4	34.8
WDS040*L5*	36.7	40.3	42.5	44.3
WDS048*L6*	44.1	48.3	51.1	53.2
WDS056*L7*	51.4	56.4	59.6	62.0

## DOUBLE FAN WIDTH

WDD017*L2*	15.8	17.3	18.3	19.1
WDD026*L2*	23.3	25.5	26.9	28.1
WDD030*L2*	27.4	30.1	31.8	33.1
WDD038*L3*	34.9	38.3	40.4	42.1
WDD046*L3*	42.1	46.2	48.8	50.8
WDD051*L4*	46.5	51.0	53.9	56.1
WDD060*L4*	55.0	60.3	63.7	66.3
WDD063*L5*	57.6	63.1	66.7	69.5
WDD080*L5*	73.6	80.7	85.2	88.8
WDD097*L6*	88.3	96.8	102.2	106.5
WDD113*L7*	103.0	112.9	119.2	124.2

THR MBH 1°F TD - R404A

Model Number	Fins Per Inch			
	8	10	12	14

## SINGLE FAN WIDTH

WDS004*L1*	4.2	4.6	4.8	5.1
WDS006*L1*	5.6	6.1	6.5	6.8
WDS008*L1*	6.6	7.2	7.6	8.0
WDS010*L2*	8.9	9.8	10.3	10.8
WDS012*L2*	11.1	12.1	12.8	13.4
WDS015*L2*	13.3	14.6	15.4	16.2
WDS019*L3*	17.5	19.2	20.2	21.2
WDS023*L3*	19.9	21.8	23.1	24.2
WDS026*L4*	23.3	25.6	27.0	28.4
WDS030*L4*	26.5	29.1	30.7	32.2
WDS032*L5*	28.3	31.0	32.7	34.4
WDS040*L5*	34.8	38.1	40.3	42.3
WDS048*L6*	41.8	45.8	48.4	50.7
WDS056*L7*	48.7	53.4	56.4	59.2

## DOUBLE FAN WIDTH

WDD017*L2*	16.5	18.1	19.1	20.0
WDD026*L2*	23.3	25.6	27.0	28.4
WDD030*L2*	26.5	29.1	30.7	32.2
WDD038*L3*	35.0	38.4	40.5	42.5
WDD046*L3*	40.7	44.7	47.2	49.5
WDD051*L4*	46.6	51.1	54.0	56.6
WDD060*L4*	53.1	58.2	61.5	64.5
WDD063*L5*	56.6	62.0	65.5	68.7
WDD080*L5*	69.7	76.4	80.7	84.6
WDD097*L6*	83.5	91.6	96.7	101.5
WDD113*L7*	97.5	106.9	112.9	118.4

\* Each asterisk represents a variable character based upon voltage and vintage ordered. See page 2 for complete nomenclature.

For R22 capacity, multiply R404A unit capacity by 1.02

For R410A capacity, multiply R404A unit capacity by 1.08

For R134a capacity multiply R404A unit capacity by .97

For R407C capacity, multiply R407A unit capacity by .98

**Notes:**

- R407A, R448A and R449A ratings are based on Mean Condensing Temperature which is the average of the Dew Point and Bubble Point temperatures corresponding to the refrigerant temperature at the condenser inlet.

‡ These models fulfill California Title 24 condenser efficiency requirements when utilizing Variable Frequency Drives and 10 FPI coils.



**Application: Retail Cooling**

# Remote Air Cooled Condensers

## Specifications - 850 RPM with 1 HP Fan Motors‡

Model Number **	Fans				Max. Circuit Qty.	Connection (Inches)^			Net Wt. (Lbs.)	Unit kW	208/3/60			460/3/60			575/3/60		
	Total Qty.	Dia.	CFM	dBA †		Dis.	Liq.	Total Qty.			FLA	MCA	MOPD	FLA	MCA	MOPD	FLA	MCA	MOPD
<b>SINGLE FAN WIDTH</b>																			
WDS004*L1*	1	30	7,400	62.2	12	1-1/8	7/8	2	350	0.9	4.0	15.0	15.0	2.0	15.0	15.0	2.1	15.0	15.0
WDS006*L1*	1	30	7,300	62.2	18	1-1/8	7/8	2	375	0.9	4.0	15.0	15.0	2.0	15.0	15.0	2.1	15.0	15.0
WDS008*L1*	1	30	7,100	62.2	24	1-1/8	7/8	2	400	0.9	4.0	15.0	15.0	2.0	15.0	15.0	2.1	15.0	15.0
WDS010*L2*	2	30	14,200	65.2	27	1-3/8	1-1/8	2	725	1.8	8.0	15.0	15.0	4.0	15.0	15.0	4.2	15.0	15.0
WDS012*L2*	2	30	14,600	65.2	27	1-3/8	1-1/8	2	750	1.8	8.0	15.0	15.0	4.0	15.0	15.0	4.2	15.0	15.0
WDS015*L2*	2	30	14,200	65.2	36	1-3/8	1-1/8	2	775	1.8	8.0	15.0	15.0	4.0	15.0	15.0	4.2	15.0	15.0
WDS019*L3*	3	30	21,900	67.0	27	1-5/8	1-3/8	2	1,125	2.7	12.0	15.1	20.0	6.0	15.0	15.0	6.3	15.0	15.0
WDS023*L3*	3	30	21,300	67.0	36	1-5/8	1-3/8	2	1,150	2.7	12.0	15.1	20.0	6.0	15.0	15.0	6.3	15.0	15.0
WDS026*L4*	4	30	29,200	68.2	27	1-5/8	1-3/8	2	1,500	3.6	16.0	17.0	20.0	8.0	15.0	15.0	8.4	15.0	15.0
WDS030*L4*	4	30	28,400	68.2	36	1-5/8	1-3/8	2	1,525	3.6	16.0	17.0	20.0	8.0	15.0	15.0	8.4	15.0	15.0
WDS032*L5*	5	30	36,500	69.2	27	2-1/8	1-5/8	2	1,875	4.5	20.0	21.0	25.0	10.0	15.0	15.0	10.5	15.0	15.0
WDS040*L5*	5	30	35,500	69.2	36	2-1/8	1-5/8	2	1,900	4.5	20.0	21.0	25.0	10.0	15.0	15.0	10.5	15.0	15.0
WDS048*L6*	6	30	42,600	70.0	36	2-1/8	1-5/8	2	2,275	5.4	24.0	25.1	30.0	12.0	15.0	15.0	12.6	15.1	20.0
WDS056*L7*	7	30	49,700	70.6	36	2-1/8	1-5/8	2	2,650	6.3	28.0	30.1	35.0	14.0	15.1	20.0	14.7	15.7	20.0

### DOUBLE FAN WIDTH

WDD017*L2*	4	30	28,400	68.2	36	1-3/8	1-1/8	4	1,500	3.6	16.0	17.0	20.0	8.0	15.0	15.0	8.4	15.0	15.0
WDD026*L2*	4	30	29,200	68.2	54	1-3/8	1-1/8	4	1,525	3.6	16.0	17.0	20.0	8.0	15.0	15.0	8.4	15.0	15.0
WDD030*L2*	4	30	28,400	68.2	72	1-3/8	1-1/8	4	1,550	3.6	16.0	17.0	20.0	8.0	15.0	15.0	8.4	15.0	15.0
WDD038*L3*	6	30	43,800	70.0	54	1-5/8	1-3/8	4	2,275	5.4	24.0	25.1	30.0	12.0	15.0	15.0	12.6	15.0	15.0
WDD046*L3*	6	30	42,600	70.0	72	1-5/8	1-3/8	4	2,300	5.4	24.0	25.1	30.0	12.0	15.0	15.0	12.6	15.0	15.0
WDD051*L4*	8	30	58,400	71.2	54	1-5/8	1-3/8	4	3,025	7.2	32.0	35.1	40.0	16.0	16.5	20.0	16.8	17.3	20.0
WDD060*L4*	8	30	56,800	71.2	72	1-5/8	1-3/8	4	3,050	7.2	32.0	35.1	40.0	16.0	16.5	20.0	16.8	17.3	20.0
WDD063*L5*	10	30	73,000	72.2	54	2-1/8	1-5/8	4	3,775	9.0	40.0	41.0	45.0	20.0	20.5	25.0	21.0	21.5	25.0
WDD080*L5*	10	30	71,000	72.2	72	2-1/8	1-5/8	4	3,800	9.0	40.0	41.0	45.0	20.0	20.5	25.0	21.0	21.5	25.0
WDD097*L6*	12	30	85,200	73.0	72	2-1/8	1-5/8	4	4,550	10.8	48.0	50.1	60.0	24.0	25.1	30.0	25.2	25.7	30.0
WDD113*L7*	14	30	99,400	73.6	72	2-1/8	1-5/8	4	5,300	12.6	56.0	60.1	70.0	28.0	30.1	35.0	29.4	30.1	35.0

\* Each asterisk represents a variable character based upon voltage and vintage ordered. See page 2 for complete nomenclature.

\*\* Models with 1 to 4 fans in length have 3/8" copper tubing, which reduces refrigerant charge. Models with 5 to 7 fans in length use 1/2" copper tubing, which reduces pressure drop.

† Sound pressure dBA @ 10 feet.

^ Standard connection sizes are for no circuit split on single wide and 50/50 circuit split on double wide models. Header diameters are one size larger than connection sizes.

Variance from standard operating conditions may result in connection sizes which are different from those listed above.

‡ These models fulfill California Title 24 condenser efficiency requirements when utilizing Variable Frequency Drives and 10 FPI coils.

Performance Data - 550 RPM with 1/3 HP Fan Motors<sup>‡</sup>

THR MBH 1°F TD - R407A, R448A, R449A

Model Number	Fins Per Inch			
	8	10	12	14

## SINGLE FAN WIDTH

WDS004*E1*	3.7	4.0	4.2	4.4
WDS005*E1*	4.9	5.4	5.7	6.0
WDS006*E1*	5.7	6.2	6.5	6.9
WDS008*E2*	7.4	8.1	8.6	9.0
WDS011*E2*	9.8	10.7	11.3	11.9
WDS012*E2*	11.2	12.3	13.0	13.6
WDS016*E3*	14.8	16.2	17.1	17.9
WDS018*E3*	16.8	18.4	19.4	20.4
WDS021*E4*	19.5	21.4	22.6	23.7
WDS025*E4*	22.6	24.8	26.2	27.5
WDS028*E5*	25.3	27.7	29.3	30.7
WDS032*E5*	28.8	31.6	33.4	35.0
WDS040*E6*	36.4	39.9	42.1	44.2
WDS046*E7*	42.4	46.4	49.0	51.4

## DOUBLE FAN WIDTH

WDD016*E2*	14.6	16.0	16.9	17.7
WDD021*E2*	19.5	21.4	22.6	23.7
WDD025*E2*	22.5	24.6	26.0	27.3
WDD032*E3*	29.5	32.3	34.1	35.8
WDD037*E3*	33.6	36.8	38.9	40.8
WDD043*E4*	39.1	42.8	45.2	47.4
WDD050*E4*	45.2	49.5	52.3	54.8
WDD055*E5*	50.5	55.3	58.4	61.3
WDD063*E5*	57.8	63.3	66.8	70.1
WDD080*E6*	72.8	79.8	84.3	88.4
WDD093*E7*	84.6	92.7	97.9	102.7

THR MBH 1°F TD - R404A

Fins Per Inch			
8	10	12	14

## SINGLE FAN WIDTH

3.7	4.1	4.3	4.5
4.8	5.3	5.6	5.9
5.3	5.8	6.1	6.4
7.5	8.2	8.7	9.1
9.6	10.5	11.1	11.6
10.5	11.5	12.2	12.7
14.4	15.8	16.7	17.5
15.8	17.3	18.3	19.2
19.1	20.9	22.1	23.2
21.3	23.3	24.6	25.8
24.0	26.3	27.8	29.1
26.5	29.1	30.7	32.2
33.5	36.7	38.8	40.7
39.0	42.7	45.1	47.3

## DOUBLE FAN WIDTH

14.9	16.3	17.2	18.1
19.1	20.9	22.1	23.2
21.1	23.1	24.4	25.6
28.7	31.5	33.3	34.9
31.5	34.5	36.5	38.2
38.1	41.8	44.2	46.3
42.4	46.5	49.1	51.5
48.3	53.0	56.0	58.7
53.1	58.2	61.5	64.5
67.0	73.5	77.7	81.4
77.8	85.3	90.1	94.5

\* Each asterisk represents a variable character based upon voltage and vintage ordered. See page 2 for complete nomenclature.

For R22 capacity, multiply R404A unit capacity by 1.02

For R410A capacity, multiply R404A unit capacity by 1.08

For R134a capacity multiply R404A unit capacity by .97

For R407C capacity, multiply R407A unit capacity by .98

**Notes:**

- R407A, R448A and R449A ratings are based on Mean Condensing Temperature which is the average of the Dew Point and Bubble Point temperatures corresponding to the refrigerant temperature at the condenser inlet.

‡ These models fulfill California Title 24 condenser efficiency requirements when utilizing Variable Frequency Drives and 10 FPI coils.



**Application: Commercial Warehouse Cooling**

# Remote Air Cooled Condensers

## Specifications - 550 RPM with 1/3 HP Fan Motors<sup>‡</sup>

Model Number **	Fans				Max. Circuit Qty.	Connection (Inches) <sup>^</sup>			Net Wt. (Lbs.)	Unit kW	208/3/60			460/3/60			575/3/60		
	Total Qty.	Dia.	CFM	dBA †		Dis.	Liq.	Total Qty.			FLA	MCA	MOPD	FLA	MCA	MOPD	FLA	MCA	MOPD
<b>SINGLE FAN WIDTH</b>																			
WDS004*E1*	1	30	5,300	49.4	12	1-1/8	7/8	2	350	0.4	2.8	15.0	15.0	1.4	15.0	15.0	-	-	-
WDS005*E1*	1	30	5,200	49.4	18	1-1/8	7/8	2	375	0.4	2.8	15.0	15.0	1.4	15.0	15.0	-	-	-
WDS006*E1*	1	30	5,100	49.4	24	1-1/8	7/8	2	400	0.4	2.8	15.0	15.0	1.4	15.0	15.0	-	-	-
WDS008*E2*	2	30	10,600	52.4	18	1-3/8	1-1/8	2	725	0.7	5.6	15.0	15.0	2.8	15.0	15.0	-	-	-
WDS011*E2*	2	30	10,400	52.4	18	1-3/8	1-1/8	2	750	0.7	5.6	15.0	15.0	2.8	15.0	15.0	-	-	-
WDS012*E2*	2	30	10,200	52.4	27	1-3/8	1-1/8	2	775	0.7	5.6	15.0	15.0	2.8	15.0	15.0	-	-	-
WDS016*E3*	3	30	15,600	54.2	27	1-5/8	1-3/8	2	1,125	1.1	8.4	15.0	15.0	4.2	15.0	15.0	-	-	-
WDS018*E3*	3	30	15,300	54.2	36	1-5/8	1-3/8	2	1,150	1.1	8.4	15.0	15.0	4.2	15.0	15.0	-	-	-
WDS021*E4*	4	30	20,800	55.4	27	1-5/8	1-3/8	2	1,500	1.4	11.2	15.0	15.0	5.6	15.0	15.0	-	-	-
WDS025*E4*	4	30	20,400	55.4	36	1-5/8	1-3/8	2	1,525	1.4	11.2	15.0	15.0	5.6	15.0	15.0	-	-	-
WDS028*E5*	5	30	26,000	56.4	27	2-1/8	1-5/8	2	1,875	1.8	14.0	15.1	20.0	7.0	15.0	15.0	-	-	-
WDS032*E5*	5	30	25,500	56.4	36	2-1/8	1-5/8	2	1,900	1.8	14.0	15.1	20.0	7.0	15.0	15.0	-	-	-
WDS040*E6*	6	30	30,600	57.2	27	2-1/8	1-5/8	2	2,275	2.1	16.8	17.5	20.0	8.4	15.0	15.0	-	-	-
WDS046*E7*	7	30	35,700	57.8	36	2-1/8	1-5/8	2	2,650	2.5	19.6	20.3	25.0	9.8	15.0	15.0	-	-	-

### DOUBLE FAN WIDTH

WDD016*E2*	4	30	21,200	55.4	36	1-3/8	1-1/8	4	1,500	1.4	11.2	15.0	15.0	5.6	15.0	15.0	-	-	-
WDD021*E2*	4	30	20,800	55.4	54	1-3/8	1-1/8	4	1,525	1.4	11.2	15.0	15.0	5.6	15.0	15.0	-	-	-
WDD025*E2*	4	30	20,400	55.4	72	1-3/8	1-1/8	4	1,550	1.4	11.2	15.0	15.0	5.6	15.0	15.0	-	-	-
WDD032*E3*	6	30	31,200	57.2	54	1-5/8	1-3/8	4	2,275	2.1	16.8	17.5	20.0	8.4	15.0	15.0	-	-	-
WDD037*E3*	6	30	30,600	57.2	72	1-5/8	1-3/8	4	2,300	2.1	16.8	17.5	20.0	8.4	15.0	15.0	-	-	-
WDD043*E4*	8	30	41,600	58.4	54	1-5/8	1-3/8	4	3,025	2.8	22.4	25.1	30.0	11.2	15.0	15.0	-	-	-
WDD050*E4*	8	30	40,800	58.4	72	1-5/8	1-3/8	4	3,050	2.8	22.4	25.1	30.0	11.2	15.0	15.0	-	-	-
WDD055*E5*	10	30	52,000	59.4	54	2-1/8	1-5/8	4	3,775	3.5	28.0	30.1	35.0	14.0	15.1	20.0	-	-	-
WDD063*E5*	10	30	51,000	59.4	72	2-1/8	1-5/8	4	3,800	3.5	28.0	30.1	35.0	14.0	15.1	20.0	-	-	-
WDD080*E6*	12	30	61,200	60.2	72	2-1/8	1-5/8	4	4,550	4.2	33.6	35.1	40.0	16.8	17.2	20.0	-	-	-
WDD093*E7*	14	30	71,400	60.8	72	2-1/8	1-5/8	4	5,300	4.9	39.2	40.1	45.0	19.6	20.1	25.0	-	-	-

\* Each asterisk represents a variable character based upon voltage and vintage ordered. See page 2 for complete nomenclature.

\*\* Models with 1 to 4 fans in length have 3/8" copper tubing, which reduces refrigerant charge. Models with 5 to 7 fans in length use 1/2" copper tubing, which reduces pressure drop.

† Sound pressure dBA @ 10 feet.

<sup>^</sup> Standard connection sizes are for no circuit split on single wide and 50/50 circuit split on double wide models. Header diameters are one size larger than connection sizes.

- Not available in 575V.

Variance from standard operating conditions may result in connection sizes which are different from those listed above.

<sup>‡</sup> These models fulfill California Title 24 condenser efficiency requirements when utilizing Variable Frequency Drives and 10 FPI coils.



Swept wing fan(s) improve air flow and diminish sound output

Stud mounted motors make for easier motor changes

## Performance Data - Models with Variable Speed EC Fan Motors - 1200 RPM

THR MBH 1°F TD - R407A, R448A, R449A

Model Number	Fins Per Inch			
	8	10	12	14

### SINGLE FAN WIDTH

WDS005*K1*	4.2	4.7	4.9	5.2
WDS006*K1*	5.8	6.4	6.7	7.1
WDS008*K1*	7.1	7.8	8.2	8.6
WDS013*K2*	11.4	12.5	13.2	13.9
WDS016*K2*	14.3	15.7	16.6	17.4
WDS019*K2*	17.6	19.3	20.3	21.3
WDS024*K3*	21.5	23.6	24.9	26.1
WDS028*K3*	25.9	28.4	30.0	31.5
WDS032*K4*	28.7	31.5	33.2	34.9
WDS038*K4*	34.3	37.6	39.7	41.7
WDS041*K5*	37.4	41.0	43.3	45.4
WDS049*K5*	45.1	49.4	52.2	54.8
WDS059*K6*	54.0	59.2	62.5	65.5
WDS069*K7*	62.9	69.0	72.9	76.5

### DOUBLE FAN WIDTH

WDD023*K2*	20.8	22.8	24.1	25.3
WDD032*K2*	28.7	31.5	33.2	34.9
WDD038*K2*	34.5	37.9	40.0	41.9
WDD047*K3*	43.0	47.2	49.8	52.2
WDD057*K3*	52.0	57.0	60.2	63.2
WDD063*K4*	57.4	62.9	66.5	69.7
WDD075*K4*	68.7	75.4	79.6	83.5
WDD082*K5*	74.7	81.9	86.5	90.7
WDD099*K5*	90.2	99.0	104.5	109.6
WDD118*K6*	107.9	118.3	124.9	131.1
WDD138*K7*	125.9	138.0	145.7	152.9

THR MBH 1°F TD - R404A

Fins Per Inch			
8	10	12	14

### SINGLE FAN WIDTH

4.4	4.9	5.1	5.4
5.9	6.5	6.9	7.2
7.1	7.8	8.2	8.6
11.7	12.9	13.6	14.3
14.7	16.1	17.0	17.9
17.5	19.1	20.2	21.2
22.0	24.1	25.5	26.7
25.6	28.1	29.7	31.2
29.3	32.1	33.9	35.6
34.0	37.3	39.4	41.3
37.5	41.1	43.4	45.5
43.7	47.9	50.6	53.1
52.3	57.3	60.5	63.5
61.1	66.9	70.7	74.2

### DOUBLE FAN WIDTH

21.9	24.0	25.4	26.6
29.3	32.1	33.9	35.6
34.2	37.5	39.6	41.6
43.9	48.1	50.8	53.3
51.5	56.5	59.6	62.6
58.6	64.2	67.8	71.2
68.0	74.5	78.7	82.6
74.9	82.1	86.7	91.0
87.5	95.9	101.3	106.3
104.6	114.7	121.2	127.1
122.0	133.8	141.3	148.2

\* Each asterisk represents a variable character based upon voltage and vintage ordered. See page 2 for complete nomenclature.

For R22 capacity, multiply R404A unit capacity by 1.02

For R410A capacity, multiply R404A unit capacity by 1.08

For R134a capacity, multiply R404A unit capacity by .97

For R407C capacity, multiply R407A unit capacity by .98

#### Notes:

- R407A, R448A and R449A ratings are based on Mean Condensing Temperature which is the average of the Dew Point and Bubble Point temperatures corresponding to the refrigerant temperature at the condenser inlet.



# Remote Air Cooled Condensers

## Specifications Data - Models with Variable Speed EC Fan Motors - 1200 RPM

Model Number **	Fans				Max. Circuit Qty.	Connection (Inches)			Net Wt. (Lbs.)	Unit kW	208/3/60			460/3/60			575/3/60		
	Total Qty.	Dia.	CFM	dBA †		Dis.	Liq.	Total Qty.			FLA	MCA	MOPD	FLA	MCA	MOPD	FLA	MCA	MOPD

### SINGLE FAN WIDTH

WDS005*K1*	1	30	11,200	72.5	12	1-1/8	7/8	2	400	2.2	7.0	15.0	15.0	2.9	15.0	15.0	-	-	-
WDS006*K1*	1	30	11,000	72.5	18	1-1/8	7/8	2	425	2.2	7.0	15.0	15.0	2.9	15.0	15.0	-	-	-
WDS008*K1*	1	30	10,700	72.5	24	1-1/8	7/8	2	450	2.2	7.0	15.0	15.0	2.9	15.0	15.0	-	-	-
WDS013*K2*	2	30	22,500	75.5	18	1-3/8	1-1/8	2	825	4.4	14.0	15.0	20.0	5.8	15.0	15.0	-	-	-
WDS016*K2*	2	30	21,900	75.5	18	1-3/8	1-1/8	2	850	4.4	14.0	15.0	20.0	5.8	15.0	15.0	-	-	-
WDS019*K2*	2	30	21,400	75.5	27	1-3/8	1-1/8	2	875	4.4	14.0	15.0	20.0	5.8	15.0	15.0	-	-	-
WDS024*K3*	3	30	32,900	77.3	27	1-5/8	1-3/8	2	1,275	6.6	21.0	21.1	25.0	8.7	15.0	15.0	-	-	-
WDS028*K3*	3	30	32,100	77.3	36	1-5/8	1-3/8	2	1,300	6.6	21.0	22.8	25.0	8.7	15.0	15.0	-	-	-
WDS032*K4*	4	30	43,900	78.5	27	1-5/8	1-3/8	2	1,700	8.8	28.0	30.1	35.0	11.6	15.0	20.0	-	-	-
WDS038*K4*	4	30	42,800	78.5	36	1-5/8	1-3/8	2	1,725	8.8	28.0	30.1	35.0	11.6	15.0	20.0	-	-	-
WDS041*K5*	5	30	54,800	79.5	27	2-1/8	1-5/8	2	2,125	11.0	35.0	36.8	40.0	14.5	15.1	20.0	-	-	-
WDS049*K5*	5	30	53,500	79.5	36	2-1/8	1-5/8	2	2,150	11.0	35.0	36.8	40.0	14.5	15.1	20.0	-	-	-
WDS059*K6*	6	30	64,200	80.3	27	2-1/8	1-5/8	2	2,575	13.2	42.0	43.8	45.0	17.4	18.1	20.0	-	-	-
WDS069*K7*	7	30	74,900	80.9	36	2-1/8	1-5/8	2	3,000	15.4	49.0	50.8	60.0	20.3	21.0	25.0	-	-	-

### DOUBLE FAN WIDTH

WDD023*K2*	4	30	44,900	78.5	36	1-3/8	1-1/8	4	1,675	8.8	28.0	30.1	35.0	11.6	15.0	15.0	-	-	-
WDD032*K2*	4	30	43,900	78.5	54	1-3/8	1-1/8	4	1,700	8.8	28.0	30.1	35.0	11.6	15.0	15.0	-	-	-
WDD038*K2*	4	30	42,800	78.5	72	1-3/8	1-1/8	4	1,725	8.8	28.0	30.1	35.0	11.6	15.0	15.0	-	-	-
WDD047*K3*	6	30	65,800	80.3	54	1-5/8	1-3/8	4	2,550	13.2	42.0	43.8	45.0	17.4	18.1	20.0	-	-	-
WDD057*K3*	6	30	64,200	80.3	72	1-5/8	1-3/8	4	2,575	13.2	42.0	43.8	45.0	17.4	18.1	20.0	-	-	-
WDD063*K4*	8	30	87,700	81.5	54	1-5/8	1-3/8	4	3,400	17.6	56.0	57.8	60.0	23.2	23.9	25.0	-	-	-
WDD075*K4*	8	30	85,600	81.5	72	1-5/8	1-3/8	4	3,425	17.6	56.0	57.8	60.0	23.2	23.9	25.0	-	-	-
WDD082*K5*	10	30	109,700	82.5	54	2-1/8	1-5/8	4	4,250	22.0	70.0	71.8	80.0	29.0	29.7	30.0	-	-	-
WDD099*K5*	10	30	107,000	82.5	72	2-1/8	1-5/8	4	4,275	22.0	70.0	71.8	80.0	29.0	29.7	30.0	-	-	-
WDD118*K6*	12	30	128,400	83.3	72	2-1/8	1-5/8	4	5,125	26.4	84.0	80.1	90.0	34.8	35.1	40.0	-	-	-
WDD138*K7*	14	30	149,800	83.9	72	2-1/8	1-5/8	4	5,975	30.8	98.0	100.1	110.0	40.6	41.3	45.0	-	-	-

\* Each asterisk represents a variable character based upon voltage and vintage ordered. See page 2 for complete nomenclature.

\*\* Models with 1 to 4 fans in length have 3/8" copper tubing, which reduces refrigerant charge. Models with 5 to 7 fans in length use 1/2" copper tubing, which reduces pressure drop.

† Sound pressure dBA @ 10 feet.

^ Standard connection sizes are for no circuit split on single wide and 50/50 circuit split on double wide models. Header diameters are one size larger than connection sizes.

- Not available in 575V.

Variance from standard operating conditions may result in connection sizes which are different from those listed above.



One to 14 fans in single and double fan width

Available with vertical or horizontal air flow to fit any refrigeration need

## Performance Data - Models with Variable Speed EC Fan Motors -900 RPM

THR MBH 1°F TD - R407A, R448A, R449A

Model Number	Fins Per Inch			
	8	10	12	14

### SINGLE FAN WIDTH

WDS004*G1*	3.3	3.7	3.9	4.0
WDS005*G1*	4.7	5.2	5.5	5.7
WDS007*G1*	6.0	6.5	6.9	7.2
WDS010*G2*	9.1	10.0	10.6	11.0
WDS014*G2*	12.7	14.0	14.8	15.4
‡WDS015*G2*	14.0	15.6	16.3	16.9
WDS021*G3*	19.3	21.1	22.3	23.2
‡WDS025*G3*	22.5	24.7	26.1	27.2
WDS028*G4*	25.5	28.0	29.5	30.7
‡WDS033*G4*	29.7	32.5	34.4	35.8
WDS035*G5*	31.8	34.9	36.8	38.4
‡WDS044*G5*	39.7	43.6	46.0	47.9
‡WDS052*G6*	47.6	52.2	55.2	57.5
‡WDS061*G7*	55.5	60.9	64.3	67.0

### DOUBLE FAN WIDTH

WDD020*G2*	17.7	19.4	20.5	21.3
WDD028*G2*	25.5	28.0	29.5	30.7
‡WDD032*G2*	28.8	31.6	33.4	34.8
WDD042*G3*	37.9	41.5	43.8	45.7
‡WDD049*G3*	44.6	48.9	51.6	53.7
WDD056*G4*	51.1	56.0	59.1	61.6
‡WDD065*G4*	59.4	65.2	68.8	71.7
WDD070*G5*	63.6	69.8	73.7	76.8
‡WDD087*G5*	79.4	87.0	91.9	95.7
‡WDD105*G6*	95.2	104.4	110.2	114.8
‡WDD122*G7*	111.1	121.8	128.6	134.0

THR MBH 1°F TD - R404A

Fins Per Inch			
8	10	12	14

### SINGLE FAN WIDTH

3.7	4.1	4.3	4.7
5.1	5.6	5.9	6.5
6.3	6.9	7.3	8.1
9.6	10.5	11.1	12.2
12.9	14.2	15.0	16.5
14.4	15.8	16.7	18.4
19.5	21.4	22.6	24.9
22.1	24.3	25.6	28.2
26.0	28.5	30.1	33.1
29.2	32.0	33.8	37.2
31.7	34.8	36.7	40.4
38.2	41.9	44.3	48.7
45.9	50.3	53.1	58.4
53.6	58.8	62.0	68.3

### DOUBLE FAN WIDTH

18.6	20.4	21.5	23.7
25.9	28.4	29.9	32.9
28.4	31.3	32.9	36.1
38.4	42.1	44.5	48.9
43.8	48.0	50.7	55.8
51.9	56.9	60.1	66.1
58.4	64.1	67.6	74.4
63.5	69.7	73.6	80.9
76.6	84.0	88.7	97.5
91.8	100.7	106.3	117.0
107.1	117.4	124.0	136.4

\* Each asterisk represents a variable character based upon voltage and vintage ordered. See page 2 for complete nomenclature.

For R22 capacity, multiply R404A unit capacity by 1.02

For R410A capacity, multiply R404A unit capacity by 1.08

For R134a capacity, multiply R404A unit capacity by .97

For R407C capacity, multiply R407A unit capacity by .98

Notes:

- R407A, R448A and R449A ratings are based on Mean Condensing Temperature which is the average of the Dew Point and Bubble Point temperatures corresponding to the refrigerant temperature at the condenser inlet.

‡ These models fulfill California Title 24 condenser efficiency requirements when utilizing 10 FPI coils.



**Application: Industrial Cooling**

# Remote Air Cooled Condensers

## Specifications Data - Models with Variable Speed EC Fan Motors -900 RPM

Model Number	Fans				Max. Circuit Qty.	Connection (Inches)			Net Wt. (Lbs.)	Unit kW	208/3/60			460/3/60			575/3/60		
	Total Qty.	Dia.	CFM	dBA †		Dis.	Liq.	Total Qty.			FLA	MCA	MOPD	FLA	MCA	MOPD	FLA	MCA	MOPD

### SINGLE FAN WIDTH

WDS004*G1*	1	30	9,000	63.5	12	1-1/8	7/8	2	400	1.2	7.0	15.0	15.0	2.9	15.0	15.0	-	-	-
WDS005*G1*	1	30	8,900	63.5	18	1-1/8	7/8	2	425	1.2	7.0	15.0	15.0	2.9	15.0	15.0	-	-	-
WDS007*G1*	1	30	8,800	63.5	24	1-1/8	7/8	2	450	1.2	7.0	15.0	15.0	2.9	15.0	15.0	-	-	-
WDS010*G2*	2	30	17,900	66.5	18	1-3/8	1-1/8	2	825	2.4	14.0	15.0	20.0	5.8	15.0	15.0	-	-	-
WDS014*G2*	2	30	17,700	66.5	18	1-3/8	1-1/8	2	850	2.4	14.0	15.0	20.0	5.8	15.0	15.0	-	-	-
‡WDS015*G2*	2	30	17,500	66.5	27	1-3/8	1-1/8	2	875	2.4	14.0	15.0	20.0	5.8	15.0	15.0	-	-	-
WDS021*G3*	3	30	26,600	68.3	27	1-5/8	1-3/8	2	1,275	3.6	21.0	21.1	25.0	8.7	15.0	15.0	-	-	-
‡WDS025*G3*	3	30	26,300	68.3	36	1-5/8	1-3/8	2	1,300	3.6	21.0	22.8	25.0	8.7	15.0	15.0	-	-	-
WDS028*G4*	4	30	35,400	69.5	27	1-5/8	1-3/8	2	1,700	4.8	28.0	29.8	30.0	11.6	15.0	20.0	-	-	-
‡WDS033*G4*	4	30	35,000	69.5	36	1-5/8	1-3/8	2	1,725	4.8	28.0	29.8	30.0	11.6	15.0	20.0	-	-	-
WDS035*G5*	5	30	44,300	70.5	27	2-1/8	1-5/8	2	2,125	6	35.0	36.8	40.0	14.5	15.1	20.0	-	-	-
‡WDS044*G5*	5	30	43,800	70.5	36	2-1/8	1-5/8	2	2,150	6	35.0	36.8	40.0	14.5	15.1	20.0	-	-	-
‡WDS052*G6*	6	30	52,500	71.3	27	2-1/8	1-5/8	2	2,575	7.2	42.0	43.8	45.0	17.4	18.1	20.0	-	-	-
‡WDS061*G7*	7	30	61,300	71.9	36	2-1/8	1-5/8	2	3,000	8.4	49.0	50.8	60.0	20.3	21.0	25.0	-	-	-

### DOUBLE FAN WIDTH

WDD020*G2*	4	30	35,900	69.5	36	1-3/8	1-1/8	4	1,675	4.8	28.0	29.8	30.0	11.6	15.0	15.0	-	-	-
WDD028*G2*	4	30	35,400	69.5	54	1-3/8	1-1/8	4	1,700	4.8	28.0	29.8	30.0	11.6	15.0	15.0	-	-	-
‡WDD032*G2*	4	30	35,000	69.5	72	1-3/8	1-1/8	4	1,725	4.8	28.0	29.8	30.0	11.6	15.0	15.0	-	-	-
WDD042*G3*	6	30	53,200	71.3	54	1-5/8	1-3/8	4	2,550	7.2	42.0	43.8	45.0	17.4	18.1	20.0	-	-	-
‡WDD049*G3*	6	30	52,500	71.3	72	1-5/8	1-3/8	4	2,575	7.2	42.0	43.8	45.0	17.4	18.1	20.0	-	-	-
WDD056*G4*	8	30	70,900	72.5	54	1-5/8	1-3/8	4	3,400	9.6	56.0	57.8	60.0	23.2	23.9	25.0	-	-	-
‡WDD065*G4*	8	30	70,000	72.5	72	1-5/8	1-3/8	4	3,425	9.6	56.0	57.8	60.0	23.2	23.9	25.0	-	-	-
WDD070*G5*	10	30	88,600	73.5	54	2-1/8	1-5/8	4	4,250	12	70.0	71.8	70.0	29	29.7	30.0	-	-	-
‡WDD087*G5*	10	30	87,600	73.5	72	2-1/8	1-5/8	4	4,275	12	70.0	71.8	70.0	29	29.7	30.0	-	-	-
‡WDD105*G6*	12	30	105,100	74.3	72	2-1/8	1-5/8	4	5,125	14.4	84.0	80.1	90.0	34.8	35.1	40.0	-	-	-
‡WDD122*G7*	14	30	122,600	74.9	72	2-1/8	1-5/8	4	5,975	16.8	98.0	100.0	110.0	40.6	41.3	45.0	-	-	-

\* Each asterisk represents a variable character based upon voltage and vintage ordered. See page 2 for complete nomenclature.

\*\* Models with 1 to 4 fans in length have 3/8" copper tubing, which reduces refrigerant charge. Models with 5 to 7 fans in length use 1/2" copper tubing, which reduces pressure drop.

† Sound pressure dBA @ 10 feet.

^ Standard connection sizes are for no circuit split on single wide and 50/50 circuit split on double wide models. Header diameters are one size larger than connection sizes.

- Not available in 575V.

Variance from standard operating conditions may result in connection sizes which are different from those listed above.

‡ These models fulfill California Title 24 condenser efficiency requirements when utilizing 10 FPI coils.

## Head Pressure Control Options and Refrigerant Charge Calculations

### FLOODED CONDENSER

The Flooded Condenser Head Pressure Control Option maintains adequate condensing pressure while operating in low ambient temperatures. By flooding the condenser with liquid refrigerant, the amount of coil surface available for condensing is reduced. The resulting reduction in capacity ensures proper operation of the thermal expansion valve(s).

This option requires that a modulating valve for each circuit, dependent on refrigerant discharge pressure, be placed at the condenser outlet. A fall in ambient temperature causes a corresponding fall in discharge pressure. The valve modulates to force liquid to back up into the condenser. Flooding the condenser reduces the available condensing surface and raises the condensing pressure so that adequate high-side pressure is maintained.

A larger receiver and additional refrigerant (supplied by others) are required for systems with flooded condenser control. The receiver can be conveniently installed directly under the condenser in most applications. However, if the system will be operational in ambient temperatures below 55° F, the receiver should be located in a warm environment or heated and insulated. In this situation, a check valve must be installed in the line between the receiver and condenser. This prevents refrigerant migration from the receiver to the condenser.

The amount of additional refrigerant charge is based on the lowest expected winter operating temperature and the design TD. In addition to the condenser charge, the operating charges of the evaporator, receiver and refrigerant lines must be added to determine the total system refrigerant charge. The pump-down capacity (80% of full capacity) of the receiver must be at least equal to the total system charge.

Table 5 shows the standard summer charge when using R407A. The additional charge required for flooded condenser operation with a design TD of 15°F is also shown. Additional charge for alternate design TDs can be found using the correction factors in Table 6. For flooded condenser control only,

$$\text{Total Charge} = \text{Summer charge (Table 5)} + \text{additional charge (Table 5)} \times \text{design TD correction factor (Table 6)}$$

### EXAMPLE: SINGLE CIRCUIT UNIT WITH FLOODED CONDENSER HEAD PRESSURE CONTROL

#### Given:

A WDD030\*B2 Condenser with a R407A summer charge of 26.6 lbs. (See Table 5) has a design TD of 10° F and will operate at a minimum ambient of 0° F.

#### Solution:

The additional charge needed to operate at 0° F can be found in Table 5 (69.0 lbs.). Because the unit has a design TD of 10° F, the additional charge must be multiplied by a correction factor of 1.04 as shown in Table 6. Therefore, the required additional charge is  $69.0 \times 1.04 = 71.8$  lbs. The total operating charge for a minimum ambient of 0° F and a 10° design TD is  $26.6 + 71.8 = 98.4$  lbs.

### EXAMPLE: MULTI-CIRCUIT UNIT WITH FLOODED CONDENSER HEAD PRESSURE CONTROL

#### Given:

A WDS012 condenser split into two circuits. One circuit has 22 face tubes of R404A at a 10° TD and the other circuit has 14 face tubes of R407A at a 15° TD. The unit will operate at a minimum ambient of 20° F.

#### Solution:

To calculate the winter charge for each circuit, the summer charge and additional charge for low ambient must be found. The summer charge can be calculated by multiplying the number of face tubes in the circuit by the charge per face tube value in Table 5. Next, divide the number of face tubes in the circuit by the total number of face tubes and multiply by the additional charge required for a minimum ambient of 20° F. Make sure to apply correction factors for design TDs other than 15° and for refrigerants other than R407A. Adding the summer charge and additional charge for low ambient will yield the total winter charge.

For the R404A circuit, the summer charge is  $22 \text{ tubes} \times 0.25 \times 0.92 \text{ lbs. (404A correction factor) per face tube} = 5.06$  lbs. The additional charge equals the ratio of tubes in the circuit to total tubes times the additional charge at 20° F with a 15° FTD times the TD correction factor from Table 6, or  $22/36 \times 20.8 \times 1.05 \times .92 = 12.26$  lbs. The winter charge is  $5.06 + 12.26 = 17.32$  lbs.

For the R407A circuit, the summer charge is  $14 \times 0.25 = 3.5$  lbs. The additional charge calculation also requires the use of the correction factor. The additional charge is  $14/36 \times 20.8 = 8.08$  lbs. The winter charge is  $3.5 + 8.08 = 11.58$  lbs.

# Remote Air Cooled Condensers

## Table 5: Additional Refrigerant Charge for Flooded Condensers

Unit Size						Number of Face Tubes	R407A, R448A, R449A*		Additional Charge Required for Low Ambient Temperatures, 15°F Design TD†				
Motor Speed (RPM)							Charge Per Face Tube (Lbs.)	Total Summer Charge (Lbs.)	Minimum Ambient Temperature (°F)				
1140	850 1.5 HP	850 1 HP	550	VSEC 1200	VSEC 900				60	40	20	0	-20
<b>SINGLE FAN-WIDTH UNITS</b>													
004	004	004	004	005	004	36	0.12	4.5	6.4	9.0	10.5	11.4	12.2
006	005	006	005	006	005		0.19	6.6	9.9	13.8	15.8	17.2	18.4
007	007	008	006	008	007	36	0.25	8.8	13.1	17.4	19.9	22.6	23.8
012	010	010	008	013	010		0.25	8.8	12.9	18.1	20.8	22.8	24.4
015	014	012	011	016	014	36	0.37	13.3	19.8	27.6	31.6	34.6	36.8
018	015	015	012	019	015		0.49	17.7	26.2	34.8	39.9	45.0	47.6
022	021	019	016	024	021	36	0.56	19.9	29.8	41.4	47.4	51.8	55.3
027	024	023	018	028	025		0.74	26.5	39.2	52.2	59.8	67.6	71.4
030	028	026	021	032	025	36	0.74	26.6	39.8	55.3	63.3	69.0	73.7
036	032	030	025	038	033		0.98	35.3	52.3	69.5	79.8	90.1	95.3
039	035	032	028	041	035	36	1.54	55.5	87.5	121.0	138.3	150.6	160.7
047	043	040	032	049	044		2.10	75.9	101.6	148.0	173.4	191.6	206.1
056	052	048	040	059	052	36	2.53	91.0	121.9	177.7	208.1	230.0	247.3
065	060	056	046	069	061		2.95	106.2	142.2	207.2	242.7	268.2	288.5
<b>DOUBLE FAN-WIDTH UNITS</b>													
022	019	017	016	023	020	72	0.25	17.7	25.8	36.2	41.7	45.7	48.8
030	028	026	021	032	028		0.37	26.6	39.8	55.3	63.3	69.0	73.7
036	031	030	025	038	032	72	0.49	35.3	52.3	69.5	79.8	90.1	92.0
045	041	038	032	047	042		0.56	39.9	105.0	145.2	166.0	180.8	188.1
054	048	046	037	057	049	72	0.74	53.0	78.5	104.4	119.6	135.2	142.8
059	055	051	043	063	056		0.74	53.2	79.5	110.4	126.5	138.1	147.4
072	065	060	050	075	065	72	0.98	70.6	104.6	139.2	159.5	180.3	190.4
078	069	063	055	082	070		1.54	110.9	175.1	242.0	276.6	301.4	321.4
094	086	080	063	099	087	72	2.10	151.7	203.2	296.0	346.8	383.2	412.2
113	103	097	080	118	105		2.53	182.0	243.8	355.2	416.2	459.9	494.6
131	121	113	093	138	122	2.95	212.3	284.5	414.4	485.6	536.5	577.2	

† Based on 90°F Condensing Temperature

\* For R22 value, multiply R407A value by 1.04

\* For R404A value, multiply R407A value by .92

\* For R134A value, multiply R407A value by 1.06

\* For R407C value, multiply R407A value by 1.0

\* For R410A value, multiply R407A value by .94

## Table 6: Low Ambient Design TD Correction Factors

Minimum Ambient Temperature (°F)	Design TD				
	30	25	20	15	10
60	0	0.40	0.76	1.00	1.24
40	0.73	0.84	0.92	1.00	1.09
20	0.86	0.92	0.95	1.00	1.05
0	0.91	0.94	0.97	1.00	1.04
-20	0.93	0.96	0.98	1.00	1.02

### FAN CYCLING CONTROL OPTION

The cycling of condenser fans provides an automatic means of maintaining condensing pressure control at low ambient air temperature conditions. It also results in substantial fan motor power savings in lower ambient. Temperature sensing thermostats or pressure controls determine whether the motor is on or off. The minimum ambient temperatures for units with the Fan Cycling Control Option can be found in Table 7 (page 22).

The Fan Cycling Control Option consists of a weatherproof enclosure, fan contactors, and either ambient thermostat(s) or pressure control(s). The enclosure is factory mounted and completely factory wired. Power must be supplied from a fused disconnect switch to the power circuit terminal block; control circuit power must be supplied to the control terminal block.

Table 8 (page 22) shows the recommended temperature set points for the thermostats. Thermostat 1 is for the second fan from the header end, Thermostat 2 for the third fan from the header end, etc. The fan(s) nearest the header end must run continuously, and can't be cycled.

### FAN SPEED CONTROL OPTION (Fan Cycling Control Option also required for this option)

Designed to enhance the performance of the Fan Cycling Control Option by reducing the RPM and air volume of the lead (header end) fan motor(s) after all other (lag) fans have cycled off. The lead fan(s) must run continuously, even in the lowest ambient temperature. By reducing their CFM, adequate head pressure can be maintained at lower ambient temperatures without resorting to flooded condenser head pressure controls. This option includes an inverter and pressure transducer. All components are factory mounted and wired. Controller decreases fan motor RPM as head pressure decreases. See Table 7 (page 22) for minimum ambient temperatures for units with both the Fan Cycling Control Option and Fan Speed Control Option.

# Quantum Air

Table 7: Minimum Ambient with Fan Cycling Control

# of Fans Long	Design TD*	Minimum Ambient Temp. (°F)	
		Without Fan Speed Control	With Fan Speed Control
2	30	35	10
	25	45	23
	20	54	37
	15	63	50
	10	72	63
3	30	15	-16
	25	28	2
	20	40	19
	15	53	37
	10	65	55
4	30	-2	-25
	25	13	-15
	20	28	6
	15	44	27
	10	59	48
5	30	-17	-25
	25	1	-25
	20	19	-5
	15	36	19
	10	54	42
6	30	-25	-25
	25	-10	-25
	20	10	-14
	15	30	12
	10	50	38
7	30	-25	-25
	25	-19	-25
	20	3	-22
	15	24	6
	10	46	34

\* Based on approximately 90°F condensing temperature.

Table 8: Recommended Fan Cycling Thermostat Settings

# of Fans Long	Design TD*	Thermostat Setpoint (°F)					
		1	2	3	4	5	6
2	30	60					
	25	65					
	20	70					
	15	75					
	10	80					
3	30	47	60				
	25	54	65				
	20	61	70				
	15	69	75				
	10	76	80				
4	30	35	51	60			
	25	45	58	65			
	20	54	64	70			
	15	63	71	75			
	10	72	77	80			
5	30	25	43	53	60		
	25	36	51	60	65		
	20	47	59	66	70		
	15	57	67	72	75		
	10	68	74	78	80		
6	30	15	35	47	55	60	
	25	28	45	54	61	65	
	20	40	54	61	66	70	
	15	53	63	69	72	75	
	10	65	72	76	78	80	
7	30	6	28	41	50	56	60
	25	20	39	49	56	61	65
	20	34	49	57	63	67	70
	15	48	59	66	70	73	75
	10	62	69	74	77	79	80

\* Based on approximately 90°F condensing temperature.

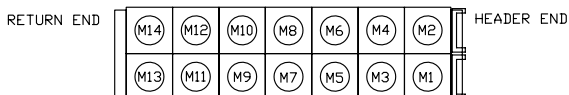
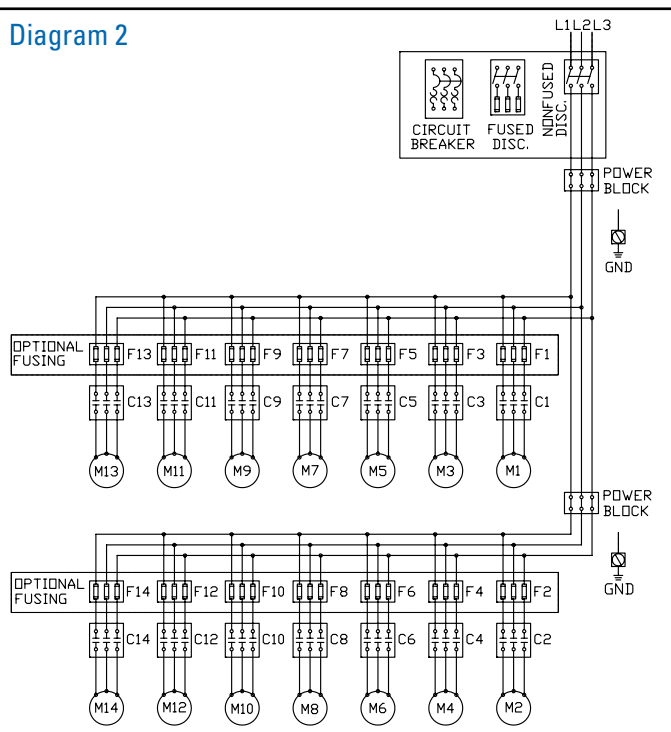
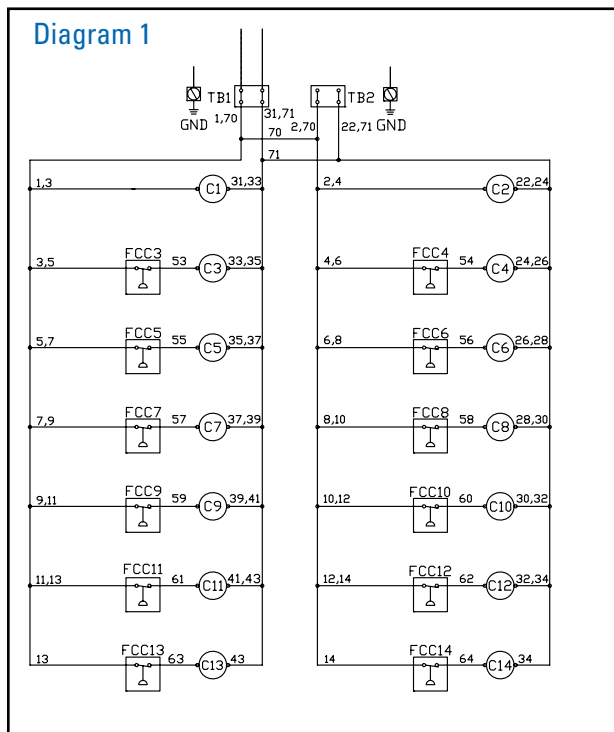

\* FCC2 - FCC14 are only present in units with Fan Cycling Control Option and can be either ambient temperature controls or pressure controls.

# Remote Air Cooled Condensers

## Physical Data - Vertical Air Discharge

### Condenser Length

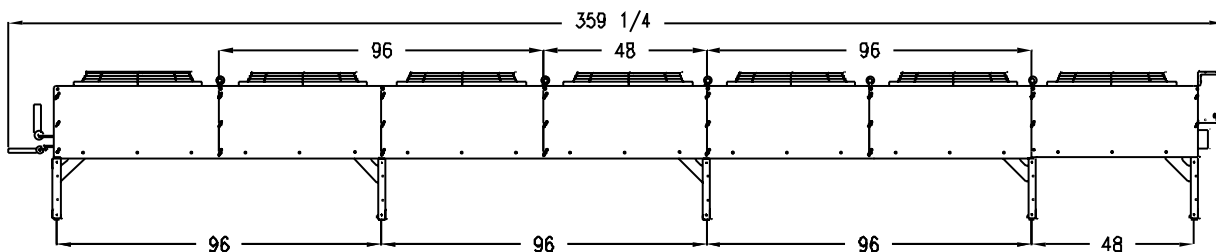
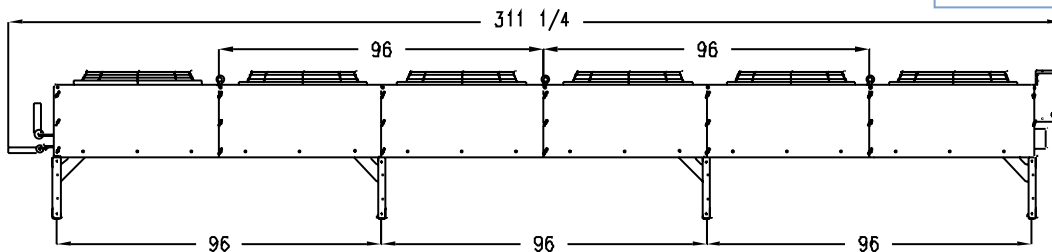
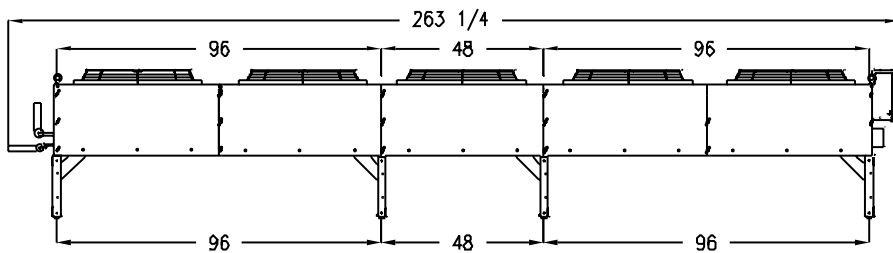
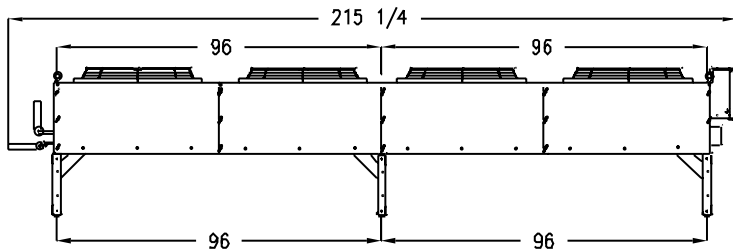
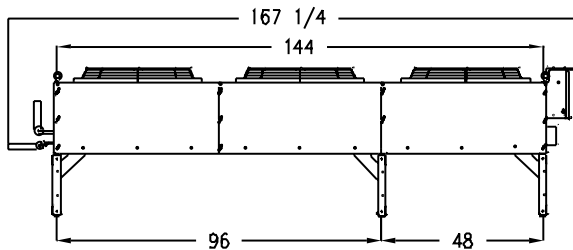
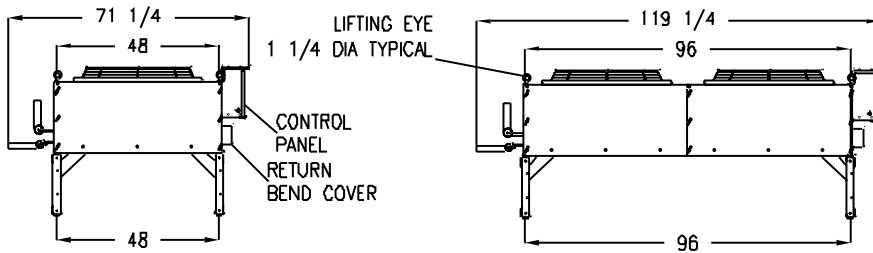

*Uniquely designed folding legs greatly assist in installation*



**Notes:**

- All dimensions are in inches.
- Utilize **all** lifting points during condenser installation. Not using all the lifting points will void the warranty.
- A wind load analysis has determined these multi-refrigerant air cooled condensers are in accordance with ASCE/SEI 7-10, Florida Building code Fifth Edition (2014) for the following location: Miami, Dade County, FL.

### Condenser Width

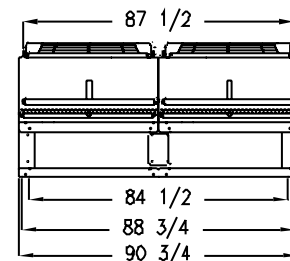
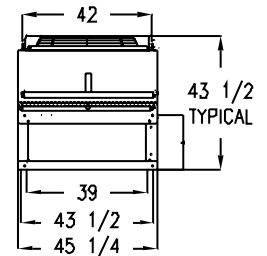

## Physical Data - Horizontal Air Discharge

### Condenser Length

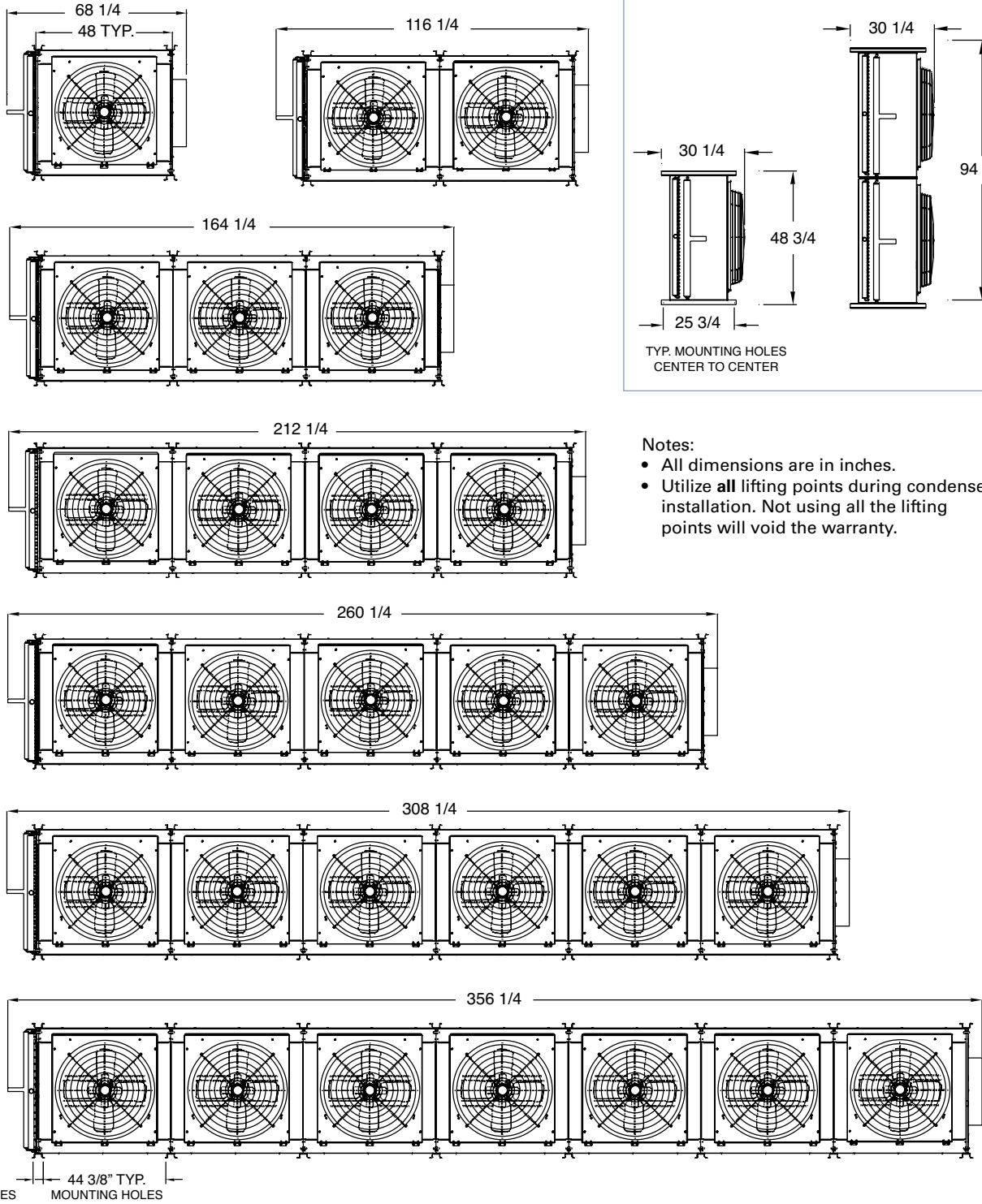

### Notes:

- All dimensions are in inches.
- Utilize **all** lifting points during condenser installation. Not using all the lifting points will void the warranty.

*Due to continuing product development, specifications are subject to change without notice.*